

GENSET MODEL	ENGINE MODEL	ALTERNATOR MODEL	WEIGHT			SKID WEIGHT		TANK CENTER OF GRAVITY FROM 01	SKID CENTER OF GRAVITY FROM 01
			WITH OIL (kg)	WITH OIL & WATER (kg)	OIL WATER & FUEL (kg)	WITH OIL (kg)	WITH OIL & WATER (kg)		
MARELLI ALTERNATOR									
P200-3	1106A-70TAG3	MJB250MB4	2062	2089	1763	1964	1991	TBC	TBC
P220-3	1106A-70TAG4	MJB250LA4	2132	2159	1833	2034	2061	1870	TBC
LEROY SOMER ALTERNATOR									
P200-3	1106A-70TAG3	LL5014D	2057	2084	2410	1959	1986	TBC	TBC
P220-3	1106A-70TAG4	LL5014F	2097	2124	2450	1999	2026	TBC	TBC

METRIC 449-5890		
SOCKET	DESCRIPTION	SIZE
A	FUEL LEVEL SWITCH	1" BSPP
B	FUEL FILL	2" BSPP
C	FUEL GAUGE	1 1/2" BSPP
D	FUEL SUPPLY	1 1/2" BSPP
E	FUEL RETURN	1 1/2" BSPP
F	REMOTE SUPPLY	1" BSPP
G	REMOTE RETURN	1" BSPP
H	SKID FUEL SUPPLY	1 1/2" BSPP
J	SKID FUEL RETURN	1 1/2" BSPP

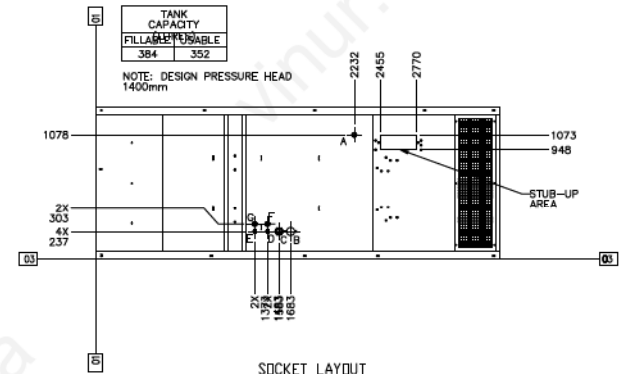

SOCKET LAYOUT
ITEMS REMOVED FOR CLARITY PURPOSE

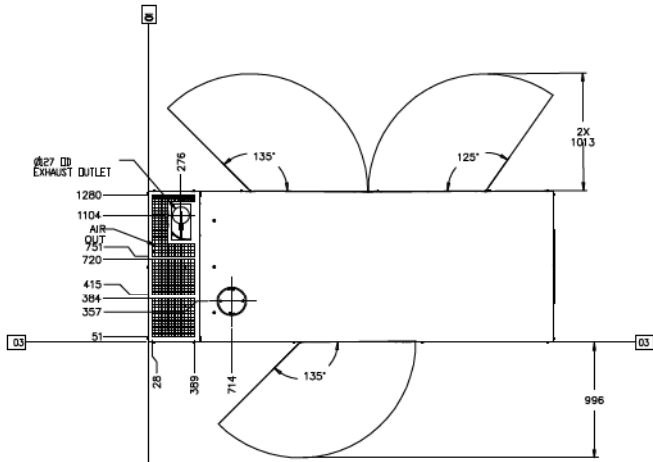
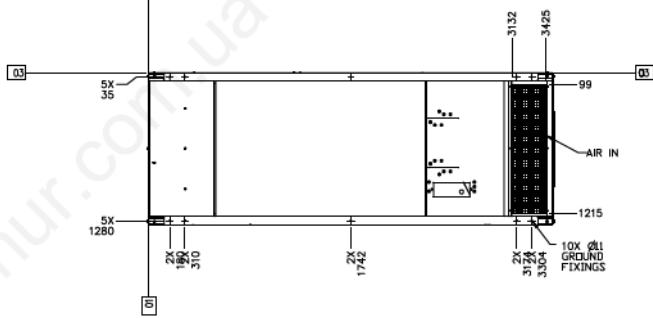
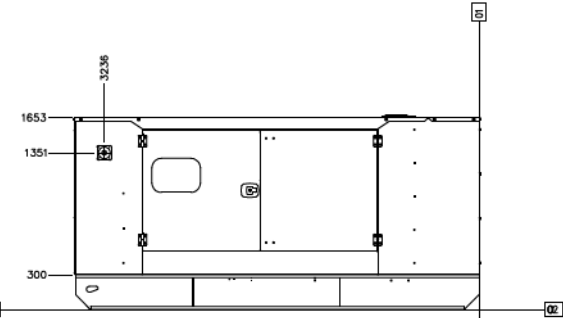
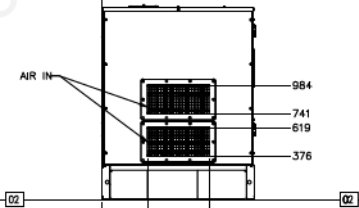
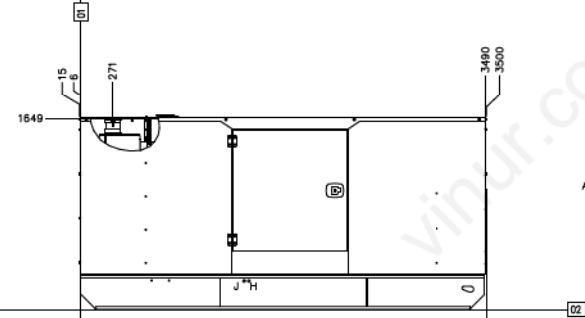
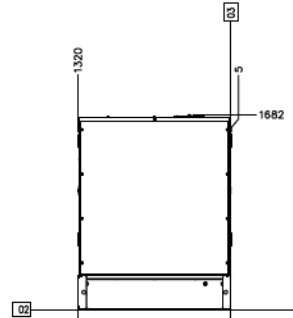

REV			
1	1E2722B	DRAWING	
2	1E019BW	LETTERS	
3	1E0013Y	CONFIDENTIALITY	
4	1E0012A	INTERPRETATION	
5	1E00011	INTERP & CONFIDENTIALITY	
6	1E00001	IDENTIFICATION	
7	1E00000	IDENTIFICATION	
8	1E00000	IDENTIFICATION	
9	1E00000	IDENTIFICATION	
10	1E00000	IDENTIFICATION	
11	1E00000	IDENTIFICATION	
12	1E00000	IDENTIFICATION	
13	1E00000	IDENTIFICATION	
14	1E00000	IDENTIFICATION	
15	1E00000	IDENTIFICATION	
16	1E00000	IDENTIFICATION	
17	1E00000	IDENTIFICATION	
18	1E00000	IDENTIFICATION	
19	1E00000	IDENTIFICATION	
20	1E00000	IDENTIFICATION	
21	1E00000	IDENTIFICATION	
22	1E00000	IDENTIFICATION	
23	1E00000	IDENTIFICATION	
24	1E00000	IDENTIFICATION	
25	1E00000	IDENTIFICATION	
26	1E00000	IDENTIFICATION	
27	1E00000	IDENTIFICATION	
28	1E00000	IDENTIFICATION	
29	1E00000	IDENTIFICATION	
30	1E00000	IDENTIFICATION	
31	1E00000	IDENTIFICATION	
32	1E00000	IDENTIFICATION	
33	1E00000	IDENTIFICATION	
34	1E00000	IDENTIFICATION	
35	1E00000	IDENTIFICATION	
36	1E00000	IDENTIFICATION	
37	1E00000	IDENTIFICATION	
38	1E00000	IDENTIFICATION	
39	1E00000	IDENTIFICATION	
40	1E00000	IDENTIFICATION	
41	1E00000	IDENTIFICATION	
42	1E00000	IDENTIFICATION	
43	1E00000	IDENTIFICATION	
44	1E00000	IDENTIFICATION	
45	1E00000	IDENTIFICATION	
46	1E00000	IDENTIFICATION	
47	1E00000	IDENTIFICATION	
48	1E00000	IDENTIFICATION	
49	1E00000	IDENTIFICATION	
50	1E00000	IDENTIFICATION	
51	1E00000	IDENTIFICATION	
52	1E00000	IDENTIFICATION	
53	1E00000	IDENTIFICATION	
54	1E00000	IDENTIFICATION	
55	1E00000	IDENTIFICATION	
56	1E00000	IDENTIFICATION	
57	1E00000	IDENTIFICATION	
58	1E00000	IDENTIFICATION	
59	1E00000	IDENTIFICATION	
60	1E00000	IDENTIFICATION	
61	1E00000	IDENTIFICATION	
62	1E00000	IDENTIFICATION	
63	1E00000	IDENTIFICATION	
64	1E00000	IDENTIFICATION	
65	1E00000	IDENTIFICATION	
66	1E00000	IDENTIFICATION	
67	1E00000	IDENTIFICATION	
68	1E00000	IDENTIFICATION	
69	1E00000	IDENTIFICATION	
70	1E00000	IDENTIFICATION	
71	1E00000	IDENTIFICATION	
72	1E00000	IDENTIFICATION	
73	1E00000	IDENTIFICATION	
74	1E00000	IDENTIFICATION	
75	1E00000	IDENTIFICATION	
76	1E00000	IDENTIFICATION	
77	1E00000	IDENTIFICATION	
78	1E00000	IDENTIFICATION	
79	1E00000	IDENTIFICATION	
80	1E00000	IDENTIFICATION	
81	1E00000	IDENTIFICATION	
82	1E00000	IDENTIFICATION	
83	1E00000	IDENTIFICATION	
84	1E00000	IDENTIFICATION	
85	1E00000	IDENTIFICATION	
86	1E00000	IDENTIFICATION	
87	1E00000	IDENTIFICATION	
88	1E00000	IDENTIFICATION	
89	1E00000	IDENTIFICATION	
90	1E00000	IDENTIFICATION	
91	1E00000	IDENTIFICATION	
92	1E00000	IDENTIFICATION	
93	1E00000	IDENTIFICATION	
94	1E00000	IDENTIFICATION	
95	1E00000	IDENTIFICATION	
96	1E00000	IDENTIFICATION	
97	1E00000	IDENTIFICATION	
98	1E00000	IDENTIFICATION	
99	1E00000	IDENTIFICATION	
100	1E00000	IDENTIFICATION	

ALL DIMENSIONS ARE REFERENCE